

ВИНТЫ КОСТНЫЕ / BONE SCREWS

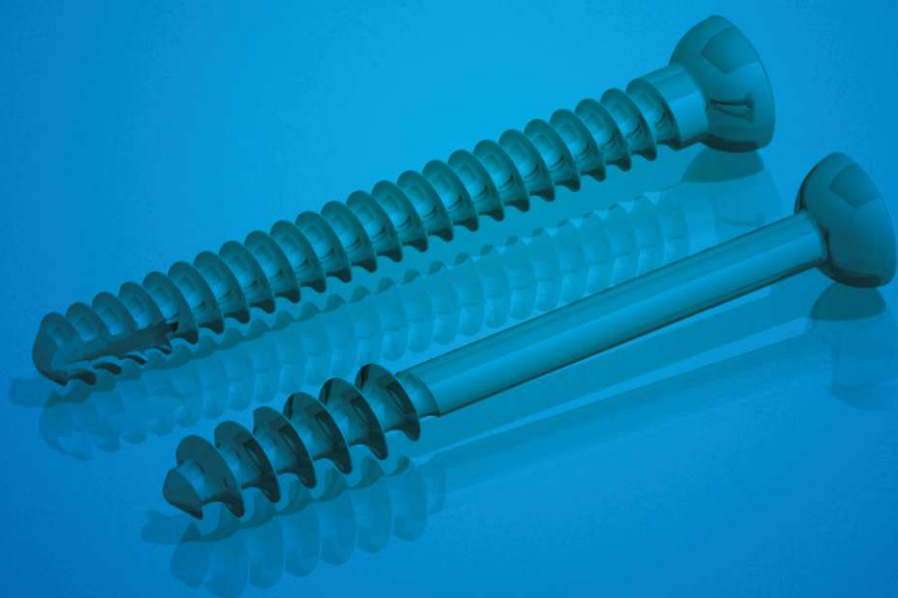

MEDGAL

сделано в польше - polish manufacturer

ДОСТУПНЫЕ ТИПЫ ВИНТОВ / AVAILABLE TYPES OF SCREWS

Первая цифра № в каталоге First part of REF №.	Типы винтов / Types of screws
4	Сталь / Steel screws
1	Титан / Titanium screws
5	Покрытие нано-кристаллическим алмазом / Nano - cristal diamond coated

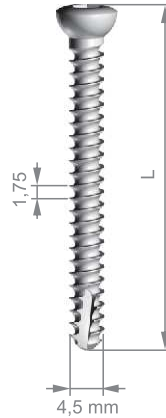
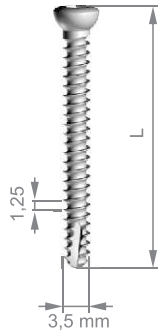
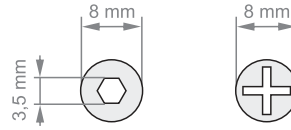
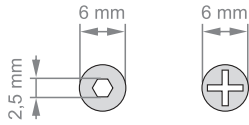

**ВИНТ КОРТИКАЛЬНЫЙ
самонарезающий
CORTICAL SCREW
self-tapping
ø 3,5 x 1,25 mm**



L [mm]	⊙	+
8	4-01-01-08	4-01-02-08
10	4-01-01-10	4-01-02-10
12	4-01-01-12	4-01-02-12
14	4-01-01-14	4-01-02-14
16	4-01-01-16	4-01-02-16
18	4-01-01-18	4-01-02-18
20	4-01-01-20	4-01-02-20
22	4-01-01-22	4-01-02-22
24	4-01-01-24	4-01-02-24
26	4-01-01-26	4-01-02-26
28	4-01-01-28	4-01-02-28
30	4-01-01-30	4-01-02-30
32	4-01-01-32	4-01-02-32
34	4-01-01-34	4-01-02-34
36	4-01-01-36	4-01-02-36
38	4-01-01-38	4-01-02-38
40	4-01-01-40	4-01-02-40
45	4-01-01-45	4-01-02-45
50	4-01-01-50	4-01-02-50
55	4-01-01-55	4-01-02-55
60	4-01-01-60	4-01-02-60
65	4-01-01-65	4-01-02-65
70	4-01-01-70	4-01-02-70
75	4-01-01-75	4-01-02-75
80	4-01-01-80	4-01-02-80
85	4-01-01-85	4-01-02-85
90	4-01-01-90	4-01-02-90
95	4-01-01-95	4-01-02-95
100	4-01-01-100	4-01-02-100
105	4-01-01-105	4-01-02-105
110	4-01-01-110	4-01-02-110
115	4-01-01-115	4-01-02-115
120	4-01-01-120	4-01-02-120

**ВИНТ КОРТИКАЛЬНЫЙ
самонарезающий
CORTICAL SCREW
self-tapping
ø 4,5 x 1,75 mm**



L [mm]	⊙	+	L [mm]	⊙	+
12	4-01-04-12	4-01-05-12	66	4-01-04-66	4-01-05-66
14	4-01-04-14	4-01-05-14	68	4-01-04-68	4-01-05-68
16	4-01-04-16	4-01-05-16	70	4-01-04-70	4-01-05-70
18	4-01-04-18	4-01-05-18	72	4-01-04-72	4-01-05-72
20	4-01-04-20	4-01-05-20	74	4-01-04-74	4-01-05-74
22	4-01-04-22	4-01-05-22	76	4-01-04-76	4-01-05-76
24	4-01-04-24	4-01-05-24	78	4-01-04-78	4-01-05-78
26	4-01-04-26	4-01-05-26	80	4-01-04-80	4-01-05-80
28	4-01-04-28	4-01-05-28	82	4-01-04-82	4-01-05-82
30	4-01-04-30	4-01-05-30	84	4-01-04-84	4-01-05-84
32	4-01-04-32	4-01-05-32	85	4-01-04-85	4-01-05-85
34	4-01-04-34	4-01-05-34	86	4-01-04-86	4-01-05-86
36	4-01-04-36	4-01-05-36	88	4-01-04-88	4-01-05-88
38	4-01-04-38	4-01-05-38	90	4-01-04-90	4-01-05-90
40	4-01-04-40	4-01-05-40	95	4-01-04-95	4-01-05-95
42	4-01-04-42	4-01-05-42	100	4-01-04-100	4-01-05-100
44	4-01-04-44	4-01-05-44	105	4-01-04-105	4-01-05-105
46	4-01-04-46	4-01-05-46	110	4-01-04-110	4-01-05-110
48	4-01-04-48	4-01-05-48	115	4-01-04-115	4-01-05-115
50	4-01-04-50	4-01-05-50	120	4-01-04-120	4-01-05-120
52	4-01-04-52	4-01-05-52	125	4-01-04-125	4-01-05-125
54	4-01-04-54	4-01-05-54	130	4-01-04-130	4-01-05-130
56	4-01-04-56	4-01-05-56	135	4-01-04-135	4-01-05-135
58	4-01-04-58	4-01-05-58	140	4-01-04-140	4-01-05-140
60	4-01-04-60	4-01-05-60	145	4-01-04-145	4-01-05-145
62	4-01-04-62	4-01-05-62	150	4-01-04-150	4-01-05-150
64	4-01-04-64	4-01-05-64			

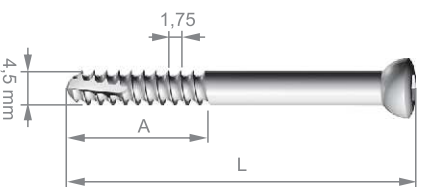
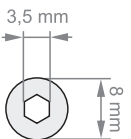

ВИНТ КОРТИКАЛЬНЫЙ
самонарезающий
CORTICAL SCREW
self-tapping
ø 4,5 x 1,75 mm



L [mm]	A [mm]	⊖	+
26	13	4-01-03-26	4-01-08-26
28	13	4-01-03-28	4-01-08-28
30	13	4-01-03-30	4-01-08-30
32	13	4-01-03-32	4-01-08-32
34	13	4-01-03-34	4-01-08-34
36	13	4-01-03-36	4-01-08-36
38	13	4-01-03-38	4-01-08-38
40	13	4-01-03-40	4-01-08-40
42	16	4-01-03-42	4-01-08-42
44	16	4-01-03-44	4-01-08-44
46	16	4-01-03-46	4-01-08-46
48	16	4-01-03-48	4-01-08-48
50	16	4-01-03-50	4-01-08-50
52	16	4-01-03-52	4-01-08-52
54	16	4-01-03-54	4-01-08-54
56	16	4-01-03-56	4-01-08-56
58	20	4-01-03-58	4-01-08-58
60	20	4-01-03-60	4-01-08-60
64	20	4-01-03-64	4-01-08-64
68	20	4-01-03-68	4-01-08-68
72	20	4-01-03-72	4-01-08-72
76	20	4-01-03-76	4-01-08-76
80	20	4-01-03-80	4-01-08-80

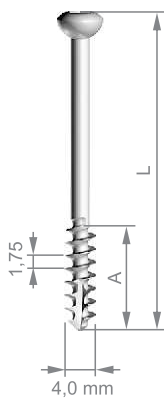
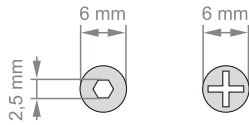

ВИНТ СПОНГИОЗНЫЙ самонарезающий
CANCELLOUS SCREW self-tapping
ø 4,0 x 1,75 mm

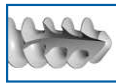

L [mm]	A [mm]	⊙	+
10	5	4-01-12-10	4-01-13-10
12	5	4-01-12-12	4-01-13-12
14	5	4-01-12-14	4-01-13-14
16	6	4-01-12-16	4-01-13-16
18	7	4-01-12-18	4-01-13-18
20	8	4-01-12-20	4-01-13-20
22	9	4-01-12-22	4-01-13-22
24	10	4-01-12-24	4-01-13-24
26	12	4-01-12-26	4-01-13-26
28	14	4-01-12-28	4-01-13-28
30	14	4-01-12-30	4-01-13-30
35	14	4-01-12-35	4-01-13-35
40	14	4-01-12-40	4-01-13-40
45	15	4-01-12-45	4-01-13-45
50	15	4-01-12-50	4-01-13-50
55	15	4-01-12-55	4-01-13-55
60	16	4-01-12-60	4-01-13-60
65	16	4-01-12-65	4-01-13-65
70	16	4-01-12-70	4-01-13-70

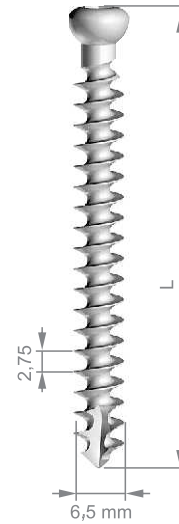
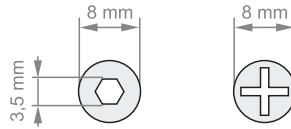

ВИНТ СПОНГИОЗНЫЙ самонарезающий
CANCELLOUS SCREW self-tapping
ø 6,5 x 2,75mm



L [mm]	⊙	+
25	4-01-15-25	4-01-16-25
30	4-01-15-30	4-01-16-30
35	4-01-15-35	4-01-16-35
40	4-01-15-40	4-01-16-40
45	4-01-15-45	4-01-16-45
50	4-01-15-50	4-01-16-50
55	4-01-15-55	4-01-16-55
60	4-01-15-60	4-01-16-60
65	4-01-15-65	4-01-16-65
70	4-01-15-70	4-01-16-70
75	4-01-15-75	4-01-16-75
80	4-01-15-80	4-01-16-80
85	4-01-15-85	4-01-16-85
90	4-01-15-90	4-01-16-90
95	4-01-15-95	4-01-16-95
100	4-01-15-100	4-01-16-100
105	4-01-15-105	4-01-16-105
110	4-01-15-110	4-01-16-110
115	4-01-15-115	4-01-16-115
120	4-01-15-120	4-01-16-120
125	4-01-15-125	4-01-16-125
130	4-01-15-130	4-01-16-130
135	4-01-15-135	4-01-16-135
140	4-01-15-140	4-01-16-140

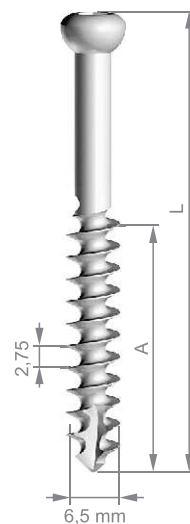
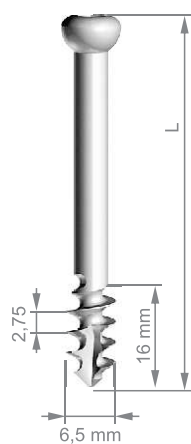
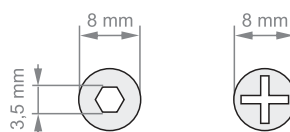
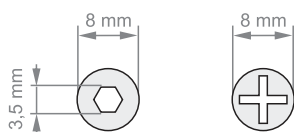

ВИНТ СПОНГИОЗНЫЙ самонарезающий
CANCELLOUS SCREW self-tapping
ø 6,5 x 2,75mm

ВИНТ СПОНГИОЗНЫЙ самонарезающий
CANCELLOUS SCREW self-tapping
ø 6,5 x 2,75mm



L [mm]	⊙	+
25	4-01-18-25	4-01-19-25
30	4-01-18-30	4-01-19-30
35	4-01-18-35	4-01-19-35
40	4-01-18-40	4-01-19-40
45	4-01-18-45	4-01-19-45
50	4-01-18-50	4-01-19-50
55	4-01-18-55	4-01-19-55
60	4-01-18-60	4-01-19-60
65	4-01-18-65	4-01-19-65
70	4-01-18-70	4-01-19-70
75	4-01-18-75	4-01-19-75
80	4-01-18-80	4-01-19-80
85	4-01-18-85	4-01-19-85
90	4-01-18-90	4-01-19-90
95	4-01-18-95	4-01-19-95
100	4-01-18-100	4-01-19-100
105	4-01-18-105	4-01-19-105
110	4-01-18-110	4-01-19-110
115	4-01-18-115	4-01-19-115
120	4-01-18-120	4-01-19-120
125	4-01-18-125	4-01-19-125
130	4-01-18-130	4-01-19-130
135	4-01-18-135	4-01-19-135
140	4-01-18-140	4-01-19-140



L [mm]	A [mm]	⊙	+
30	22	4-01-21-30	4-01-22-30
35	27	4-01-21-35	4-01-22-35
40	32	4-01-21-40	4-01-22-40
45	32	4-01-21-45	4-01-22-45
50	32	4-01-21-50	4-01-22-50
55	32	4-01-21-55	4-01-22-55
60	32	4-01-21-60	4-01-22-60
65	32	4-01-21-65	4-01-22-65
70	32	4-01-21-70	4-01-22-70
75	32	4-01-21-75	4-01-22-75
80	32	4-01-21-80	4-01-22-80
85	32	4-01-21-85	4-01-22-85
90	32	4-01-21-90	4-01-22-90
95	32	4-01-21-95	4-01-22-95
100	32	4-01-21-100	4-01-22-100
105	32	4-01-21-105	4-01-22-105
110	32	4-01-21-110	4-01-22-110
115	32	4-01-21-115	4-01-22-115
120	32	4-01-21-120	4-01-22-120
125	32	4-01-21-125	4-01-22-125
130	32	4-01-21-130	4-01-22-130
135	32	4-01-21-135	4-01-22-135
140	32	4-01-21-140	4-01-22-140
145	32	4-01-21-145	4-01-22-145
150	32	4-01-21-150	4-01-22-150

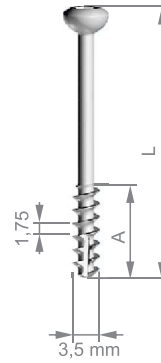
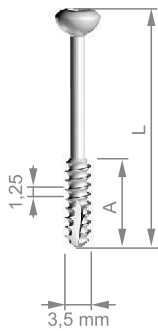
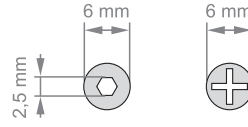
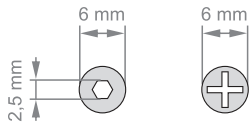

**ВИНТ НАВИКУЛЯРНЫЙ
самонарезающий**
NAVICULAR SCREW
self-tapping
ø 3,5 x 1,25 mm



**ВИНТ НАВИКУЛЯРНЫЙ ИЛИ СПОНГИОЗНЫЙ
самонарезающий**
NAVICULAR OR CANCELLOUS SCREW
self-tapping
ø 3,5 x 1,75 mm



L [mm]	A [mm]	⊙	+
8	4	4-01-06-08	4-01-07-08
10	5	4-01-06-10	4-01-07-10
12	6	4-01-06-12	4-01-07-12
14	6	4-01-06-14	4-01-07-14
16	6	4-01-06-16	4-01-07-16
18	8	4-01-06-18	4-01-07-18
20	8	4-01-06-20	4-01-07-20
22	10	4-01-06-22	4-01-07-22
24	10	4-01-06-24	4-01-07-24
26	10	4-01-06-26	4-01-07-26
28	10	4-01-06-28	4-01-07-28
30	12	4-01-06-30	4-01-07-30
32	12	4-01-06-32	4-01-07-32

L [mm]	A [mm]	⊙	+
10	5	4-01-09-10	4-01-10-10
12	6	4-01-09-12	4-01-10-12
14	6	4-01-09-14	4-01-10-14
16	6	4-01-09-16	4-01-10-16
18	8	4-01-09-18	4-01-10-18
20	8	4-01-09-20	4-01-10-20
22	10	4-01-09-22	4-01-10-22
24	10	4-01-09-24	4-01-10-24
26	10	4-01-09-26	4-01-10-26
28	10	4-01-09-28	4-01-10-28
30	12	4-01-09-30	4-01-10-30
32	12	4-01-09-32	4-01-10-32
34	12	4-01-09-34	4-01-10-34
36	12	4-01-09-36	4-01-10-36
38	14	4-01-09-38	4-01-10-38
40	14	4-01-09-40	4-01-10-40
42	14	4-01-09-42	4-01-10-42
44	16	4-01-09-44	4-01-10-44
46	16	4-01-09-46	4-01-10-46
48	16	4-01-09-48	4-01-10-48
50	16	4-01-09-50	4-01-10-50
52	18	4-01-09-52	4-01-10-52
54	18	4-01-09-54	4-01-10-54
56	18	4-01-09-56	4-01-10-56
58	18	4-01-09-58	4-01-10-58
60	18	4-01-09-60	4-01-10-60

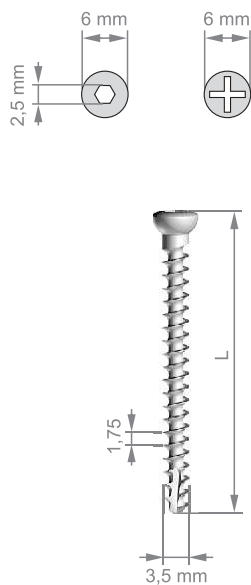

**ВИНТ НАВИКУЛЯРНЫЙ
самонарезающий**
NAVICULAR SCREW
self-tapping

ø 3,5 x 1,75mm



L [mm]	⊙	+
10	4-01-24-10	4-01-25-10
12	4-01-24-12	4-01-25-12
14	4-01-24-14	4-01-25-14
16	4-01-24-16	4-01-25-16
18	4-01-24-18	4-01-25-18
20	4-01-24-20	4-01-25-20
22	4-01-24-22	4-01-25-22
24	4-01-24-24	4-01-25-24
26	4-01-24-26	4-01-25-26
28	4-01-24-28	4-01-25-28
30	4-01-24-30	4-01-25-30
32	4-01-24-32	4-01-25-32
34	4-01-24-34	4-01-25-34
35	4-01-24-35	4-01-25-35
36	4-01-24-36	4-01-25-36
38	4-01-24-38	4-01-25-38
40	4-01-24-40	4-01-25-40
42	4-01-24-42	4-01-25-42
44	4-01-24-44	4-01-25-44
45	4-01-24-45	4-01-25-45
46	4-01-24-46	4-01-25-46
48	4-01-24-48	4-01-25-48
50	4-01-24-50	4-01-25-50
55	4-01-24-55	4-01-25-55
60	4-01-24-60	4-01-25-60
65	4-01-24-65	4-01-25-65
70	4-01-24-70	4-01-25-70
75	4-01-24-75	4-01-25-75
80	4-01-24-80	4-01-25-80
85	4-01-24-85	4-01-25-85
90	4-01-24-90	4-01-25-90
95	4-01-24-95	4-01-25-95
100	4-01-24-100	4-01-25-100

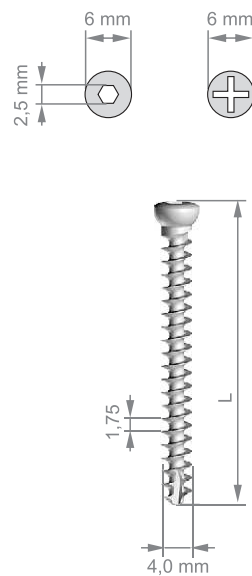

**ВИНТ НАВИКУЛЯРНЫЙ
самонарезающий**
NAVICULAR SCREW
self-tapping

ø 4,0 x 1,75mm



L [mm]	⊙	+
8	4-01-27-08	4-01-28-08
10	4-01-27-10	4-01-28-10
12	4-01-27-12	4-01-28-12
14	4-01-27-14	4-01-28-14
16	4-01-27-16	4-01-28-16
18	4-01-27-18	4-01-28-18
20	4-01-27-20	4-01-28-20
22	4-01-27-22	4-01-28-22
24	4-01-27-24	4-01-28-24
26	4-01-27-26	4-01-28-26
28	4-01-27-28	4-01-28-28
30	4-01-27-30	4-01-28-30
32	4-01-27-32	4-01-28-32
34	4-01-27-34	4-01-28-34
35	4-01-27-35	4-01-28-35
36	4-01-27-36	4-01-28-36
38	4-01-27-38	4-01-28-38
40	4-01-27-40	4-01-28-40
42	4-01-27-42	4-01-28-42
44	4-01-27-44	4-01-28-44
45	4-01-27-45	4-01-28-45
46	4-01-27-46	4-01-28-46
48	4-01-27-48	4-01-28-48
50	4-01-27-50	4-01-28-50
52	4-01-27-52	4-01-28-52
54	4-01-27-54	4-01-28-54
55	4-01-27-55	4-01-28-55
56	4-01-27-56	4-01-28-56
58	4-01-27-58	4-01-28-58
60	4-01-27-60	4-01-28-60
65	4-01-27-65	4-01-28-65
70	4-01-27-70	4-01-28-70

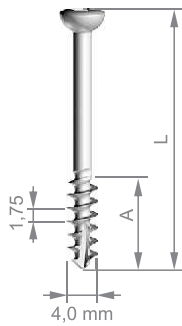
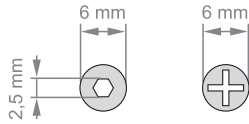

**ВИНТ НАВИКУЛЯРНЫЙ
самонарезающий**
NAVICULAR SCREW
self-tapping
ø 4,0 x 1,75mm



L [mm]	A [mm]	⊙	+
10	7	4-01-29-10	4-01-38-10
12	7	4-01-29-12	4-01-38-12
14	7	4-01-29-14	4-01-38-14
16	7	4-01-29-16	4-01-38-16
28	12	4-01-29-28	4-01-38-28
30	12	4-01-29-30	4-01-38-30
32	12	4-01-29-32	4-01-38-32
34	12	4-01-29-34	4-01-38-34
36	12	4-01-29-36	4-01-38-36
38	12	4-01-29-38	4-01-38-38
40	12	4-01-29-40	4-01-38-40
42	12	4-01-29-42	4-01-38-42
44	12	4-01-29-44	4-01-38-44
45	15	4-01-29-45	4-01-38-45
50	15	4-01-29-50	4-01-38-50
55	17	4-01-29-55	4-01-38-55
60	19	4-01-29-60	4-01-38-60
65	20	4-01-29-65	4-01-38-65
70	22	4-01-29-70	4-01-38-70

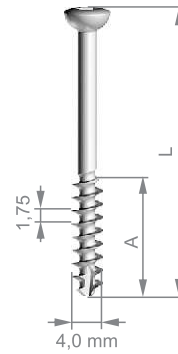
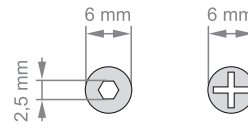

**ВИНТ НАВИКУЛЯРНЫЙ
самонарезающий**
NAVICULAR SCREW
self-tapping
ø 4,0 x 1,75mm



L [mm]	A [mm]	⊙	+
8	5	4-01-30-08	4-01-31-08
10	5	4-01-30-10	4-01-31-10
12	5	4-01-30-12	4-01-31-12
14	5	4-01-30-14	4-01-31-14
16	6	4-01-30-16	4-01-31-16
18	7	4-01-30-18	4-01-31-18
20	8	4-01-30-20	4-01-31-20
22	9	4-01-30-22	4-01-31-22
24	10	4-01-30-24	4-01-31-24
26	12	4-01-30-26	4-01-31-26
28	14	4-01-30-28	4-01-31-28
30	14	4-01-30-30	4-01-31-30
32	14	4-01-30-32	4-01-31-32
34	14	4-01-30-34	4-01-31-34
35	14	4-01-30-35	4-01-31-35
36	14	4-01-30-36	4-01-31-36
38	14	4-01-30-38	4-01-31-38
40	14	4-01-30-40	4-01-31-40
42	15	4-01-30-42	4-01-31-42
44	15	4-01-30-44	4-01-31-44
46	15	4-01-30-46	4-01-31-46
48	15	4-01-30-48	4-01-31-48
50	16	4-01-30-50	4-01-31-50
55	16	4-01-30-55	4-01-31-55
60	16	4-01-30-60	4-01-31-60
65	16	4-01-30-65	4-01-31-65
70	16	4-01-30-70	4-01-31-70

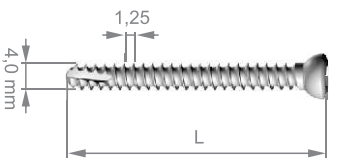
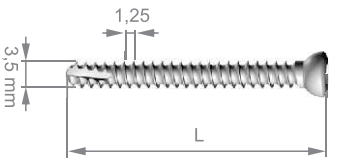
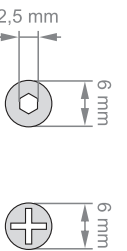
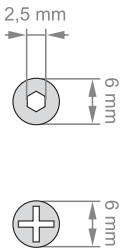

**ВИНТ SHERMAN'S
SHERMAN'S SCREW**
ø 3,5 x 1,25mm

**ВИНТ SHERMAN'S
SHERMAN'S SCREW**
ø 4,0 x 1,25mm



L [mm]	⊙	+
10	4-01-36-10	4-01-37-10
13	4-01-36-13	4-01-37-13
16	4-01-36-16	4-01-37-16
19	4-01-36-19	4-01-37-19
22	4-01-36-22	4-01-37-22
25	4-01-36-25	4-01-37-25
28	4-01-36-28	4-01-37-28
31	4-01-36-31	4-01-37-31
34	4-01-36-34	4-01-37-34
37	4-01-36-37	4-01-37-37
40	4-01-36-40	4-01-37-40
43	4-01-36-43	4-01-37-43
46	4-01-36-46	4-01-37-46
50	4-01-36-50	4-01-37-50
55	4-01-36-55	4-01-37-55
60	4-01-36-60	4-01-37-60
65	4-01-36-65	4-01-37-65
70	4-01-36-70	4-01-37-70
75	4-01-36-75	4-01-37-75

L [mm]	⊙	+
10	4-01-39-10	4-01-40-10
13	4-01-39-13	4-01-40-13
16	4-01-39-16	4-01-40-16
19	4-01-39-19	4-01-40-19
22	4-01-39-22	4-01-40-22
25	4-01-39-25	4-01-40-25
28	4-01-39-28	4-01-40-28
31	4-01-39-31	4-01-40-31
34	4-01-39-34	4-01-40-34
37	4-01-39-37	4-01-40-37
40	4-01-39-40	4-01-40-40
43	4-01-39-43	4-01-40-43
46	4-01-39-46	4-01-40-46
50	4-01-39-50	4-01-40-50
55	4-01-39-55	4-01-40-55
60	4-01-39-60	4-01-40-60
65	4-01-39-65	4-01-40-65
70	4-01-39-70	4-01-40-70
75	4-01-39-75	4-01-40-75

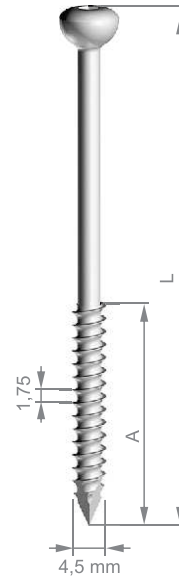
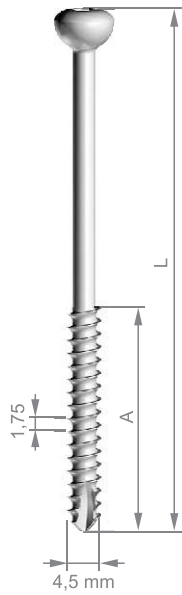
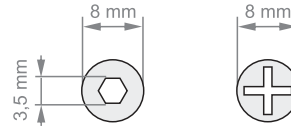
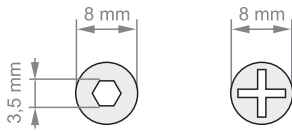

▲
ВИНТ МАЛЛЕОЛЯРНЫЙ
самонарезающий
MALLEOLAR SCREW
self-tapping
ø 4,5 x 1,75mm



L [mm]	A [mm]	⊙	⊕
20	10	4-01-32-20	4-01-35-20
25	12	4-01-32-25	4-01-35-25
30	15	4-01-32-30	4-01-35-30
35	17	4-01-32-35	4-01-35-35
40	20	4-01-32-40	4-01-35-40
45	22	4-01-32-45	4-01-35-45
50	25	4-01-32-50	4-01-35-50
55	27	4-01-32-55	4-01-35-55
60	29	4-01-32-60	4-01-35-60
65	31	4-01-32-65	4-01-35-65
70	33	4-01-32-70	4-01-35-70
75	37	4-01-32-75	4-01-35-75
80	40	4-01-32-80	4-01-35-80
85	42	4-01-32-85	4-01-35-85
90	45	4-01-32-90	4-01-35-90
95	47	4-01-32-95	4-01-35-95
100	50	4-01-32-100	4-01-35-100
105	52	4-01-32-105	4-01-35-105
110	55	4-01-32-110	4-01-35-110
115	57	4-01-32-115	4-01-35-115
120	60	4-01-32-120	4-01-35-120

▲
ВИНТ МАЛЛЕОЛЯРНЫЙ
самонарезающий
MALLEOLAR SCREW
self-tapping
ø 4,5 x 1,75mm



L [mm]	A [mm]	⊙	⊕
20	10	4-01-33-20	4-01-34-20
25	12	4-01-33-25	4-01-34-25
30	15	4-01-33-30	4-01-34-30
35	17	4-01-33-35	4-01-34-35
40	20	4-01-33-40	4-01-34-40
45	22	4-01-33-45	4-01-34-45
50	25	4-01-33-50	4-01-34-50
55	27	4-01-33-55	4-01-34-55
60	29	4-01-33-60	4-01-34-60
65	31	4-01-33-65	4-01-34-65
70	33	4-01-33-70	4-01-34-70
75	37	4-01-33-75	4-01-34-75
80	40	4-01-33-80	4-01-34-80
85	42	4-01-33-85	4-01-34-85
90	45	4-01-33-90	4-01-34-90
95	47	4-01-33-95	4-01-34-95
100	50	4-01-33-100	4-01-34-100
105	52	4-01-33-105	4-01-34-105
110	55	4-01-33-110	4-01-34-110
115	57	4-01-33-115	4-01-34-115
120	60	4-01-33-120	4-01-34-120

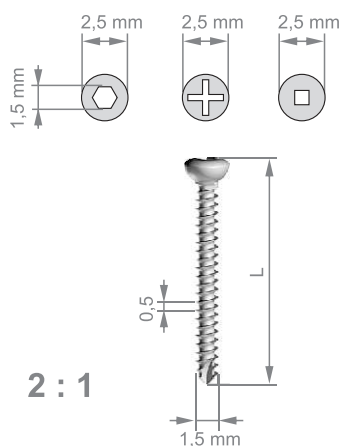

2 : 1

ВИНТ ДЛЯ МЕЛКИХ КОСТЕЙ самонарезающий

SCREW FOR SMALL BONE FRAGMENTS self-tapping

ø 1,5 x 0,5mm

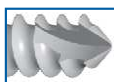

L [mm]	⊙	+	⊠
5	4-01-42-05	4-01-43-05	4-01-44-05
6	4-01-42-06	4-01-43-06	4-01-44-06
7	4-01-42-07	4-01-43-07	4-01-44-07
8	4-01-42-08	4-01-43-08	4-01-44-08
9	4-01-42-09	4-01-43-09	4-01-44-09
10	4-01-42-10	4-01-43-10	4-01-44-10
11	4-01-42-11	4-01-43-11	4-01-44-11
12	4-01-42-12	4-01-43-12	4-01-44-12
14	4-01-42-14	4-01-43-14	4-01-44-14
16	4-01-42-16	4-01-43-16	4-01-44-16
18	4-01-42-18	4-01-43-18	4-01-44-18
20	4-01-42-20	4-01-43-20	4-01-44-20
22	4-01-42-22	4-01-43-22	4-01-44-22

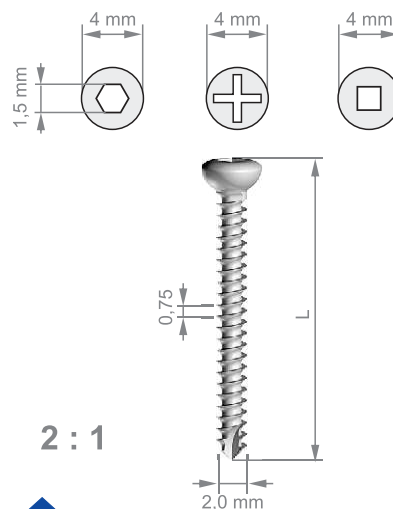

2 : 1

ВИНТ ДЛЯ МЕЛКИХ КОСТЕЙ самонарезающий

SCREW FOR SMALL BONE FRAGMENTS self-tapping

ø 2,0 x 0,75mm



L [mm]	⊙	+	⊠
5	4-01-45-05	4-01-46-05	4-01-47-05
6	4-01-45-06	4-01-46-06	4-01-47-06
8	4-01-45-08	4-01-46-08	4-01-47-08
10	4-01-45-10	4-01-46-10	4-01-47-10
12	4-01-45-12	4-01-46-12	4-01-47-12
14	4-01-45-14	4-01-46-14	4-01-47-14
16	4-01-45-16	4-01-46-16	4-01-47-16
18	4-01-45-18	4-01-46-18	4-01-47-18
20	4-01-45-20	4-01-46-20	4-01-47-20
22	4-01-45-22	4-01-46-22	4-01-47-22
24	4-01-45-24	4-01-46-24	4-01-47-24
26	4-01-45-26	4-01-46-26	4-01-47-26
28	4-01-45-28	4-01-46-28	4-01-47-28
30	4-01-45-30	4-01-46-30	4-01-47-30
32	4-01-45-32	4-01-46-32	4-01-47-32
34	4-01-45-34	4-01-46-34	4-01-47-34
36	4-01-45-36	4-01-46-36	4-01-47-36
38	4-01-45-38	4-01-46-38	4-01-47-38
40	4-01-45-40	4-01-46-40	4-01-47-40

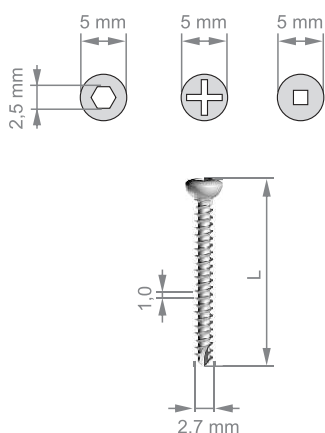

ВИНТ ДЛЯ МЕЛКИХ КОСТЕЙ самонарезающий

SCREW FOR SMALL BONE FRAGMENTS self-tapping

ø 2,7 x 1,0mm



L [mm]	⊙	+	⊠
6	4-01-48-06	4-01-49-06	4-01-50-06
8	4-01-48-08	4-01-49-08	4-01-50-08
10	4-01-48-10	4-01-49-10	4-01-50-10
12	4-01-48-12	4-01-49-12	4-01-50-12
14	4-01-48-14	4-01-49-14	4-01-50-14
16	4-01-48-16	4-01-49-16	4-01-50-16
18	4-01-48-18	4-01-49-18	4-01-50-18
20	4-01-48-20	4-01-49-20	4-01-50-20
22	4-01-48-22	4-01-49-22	4-01-50-22
24	4-01-48-24	4-01-49-24	4-01-50-24
26	4-01-48-26	4-01-49-26	4-01-50-26
28	4-01-48-28	4-01-49-28	4-01-50-28
30	4-01-48-30	4-01-49-30	4-01-50-30
32	4-01-48-32	4-01-49-32	4-01-50-32
34	4-01-48-34	4-01-49-34	4-01-50-34
36	4-01-48-36	4-01-49-36	4-01-50-36
38	4-01-48-38	4-01-49-38	4-01-50-38
40	4-01-48-40	4-01-49-40	4-01-50-40
42	4-01-48-42	4-01-49-42	4-01-50-42
44	4-01-48-44	4-01-49-44	4-01-50-44

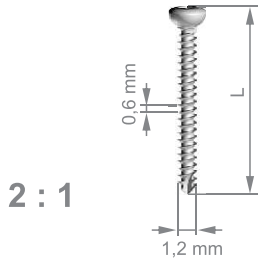
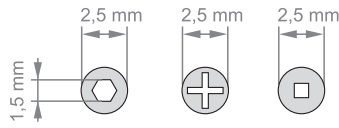

2 : 1

**ВИНТ ДЛЯ МЕЛКИХ КОСТЕЙ
самонарезающий**
**SCREW FOR SMALL BONE FRAGMENTS
self-tapping**
ø 1,2 x 0,6mm

L [mm]	⊙	+	□
4	4-01-93-04	4-01-94-04	4-01-95-04
5	4-01-93-05	4-01-94-05	4-01-95-05
6	4-01-93-06	4-01-94-06	4-01-95-06
7	4-01-93-07	4-01-94-07	4-01-95-07
8	4-01-93-08	4-01-94-08	4-01-95-08
9	4-01-93-09	4-01-94-09	4-01-95-09
10	4-01-93-10	4-01-94-10	4-01-95-10

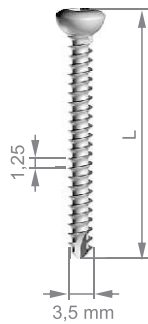
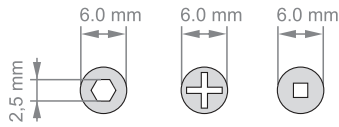

**ВИНТ ДЛЯ МЕЛКИХ КОСТЕЙ
самонарезающий**
**SCREW FOR SMALL BONE FRAGMENTS
self-tapping**
ø 3,5 x 1,25mm

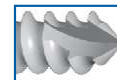

L [mm]	⊙	+	□	L [mm]	⊙	+	□
8	4-01-51-08	4-01-52-08	4-01-53-08	40	4-01-51-40	4-01-52-40	4-01-53-40
10	4-01-51-10	4-01-52-10	4-01-53-10	42	4-01-51-42	4-01-52-42	4-01-53-42
12	4-01-51-12	4-01-52-12	4-01-53-12	44	4-01-51-44	4-01-52-44	4-01-53-44
14	4-01-51-14	4-01-52-14	4-01-53-14	46	4-01-51-46	4-01-52-46	4-01-53-46
16	4-01-51-16	4-01-52-16	4-01-53-16	48	4-01-51-48	4-01-52-48	4-01-53-48
18	4-01-51-18	4-01-52-18	4-01-53-18	50	4-01-51-50	4-01-52-50	4-01-53-50
20	4-01-51-20	4-01-52-20	4-01-53-20	52	4-01-51-52	4-01-52-52	4-01-53-52
22	4-01-51-22	4-01-52-22	4-01-53-22	54	4-01-51-54	4-01-52-54	4-01-53-54
24	4-01-51-24	4-01-52-24	4-01-53-24	56	4-01-51-56	4-01-52-56	4-01-53-56
26	4-01-51-26	4-01-52-26	4-01-53-26	58	4-01-51-58	4-01-52-58	4-01-53-58
28	4-01-51-28	4-01-52-28	4-01-53-28	60	4-01-51-60	4-01-52-60	4-01-53-60
30	4-01-51-30	4-01-52-30	4-01-53-30	62	4-01-51-62	4-01-52-62	4-01-53-62
32	4-01-51-32	4-01-52-32	4-01-53-32	64	4-01-51-64	4-01-52-64	4-01-53-64
34	4-01-51-34	4-01-52-34	4-01-53-34	66	4-01-51-66	4-01-52-66	4-01-53-66
36	4-01-51-36	4-01-52-36	4-01-53-36	68	4-01-51-68	4-01-52-68	4-01-53-68
38	4-01-51-38	4-01-52-38	4-01-53-38	70	4-01-51-70	4-01-52-70	4-01-53-70

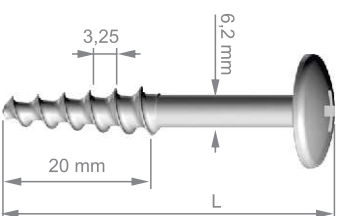
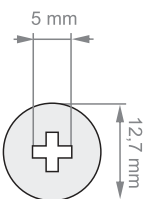
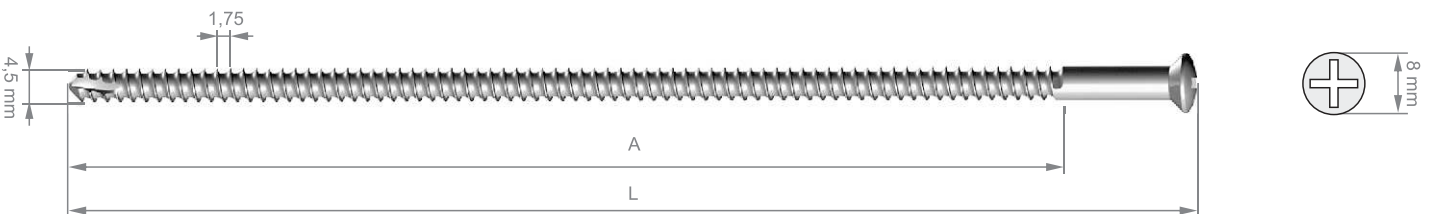

▶ **ВИНТ ЗАЖИМНОЙ ВОСВОРТН**
ВОСВОРТН CLAMP SCREW
 ø 6,2 x 3,25mm

L [mm]	+
38	4-01-65-01
41	4-01-65-02
44	4-01-65-03

▶ **ВИНТ ЛЮКТЕВОЙ**
ELBOW SCREW
 ø 4,5 x 1,75mm



L [mm]	A [mm]	+
102	82	4-01-54-01
127	107	4-01-54-02
152	132	4-01-54-03

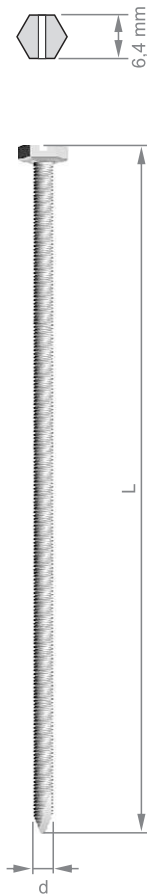

▲
ВИНТ КОЛЕННЫЙ
KNEE SCREW

L [mm]	d [mm]		
	M2,5x0,45	M3,0x0,5	M3,5x0,65
64	4-01-56-01	4-01-57-01	4-01-58-01
76	4-01-56-02	4-01-57-02	4-01-58-02
89	4-01-56-03	4-01-57-03	4-01-58-03
102	4-01-56-04	4-01-57-04	4-01-58-04
114	4-01-56-05	4-01-57-05	4-01-58-05
127	4-01-56-06	4-01-57-06	4-01-58-06

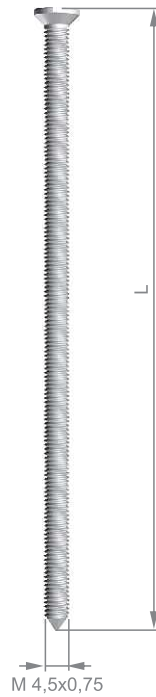
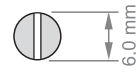

▲
ВИНТ КОЛЕННЫЙ
KNEE SCREW
M 4,5 x 0,75mm



▲
ШАЙБА \varnothing 11
1шт./компл.
4-01-60-00/1



▲
ГАЙКА
M 4,5 x 0,75
1шт./компл.
4-01-60-00/2

L [mm]	Ø
51	4-01-60-01
57	4-01-60-02
64	4-01-60-03
70	4-01-60-04
76	4-01-60-05
83	4-01-60-06
89	4-01-60-07
95	4-01-60-08
102	4-01-60-09

A



▲
ГАЙКА БЛОКИРУЮЩАЯ 1шт./компл.

B



▲
ШАЙБА \varnothing 9,5 1шт./компл.

L [mm]	A	B
M2,5x0,45	4-01-56-00/1	4-01-56-00/2
M3,0x0,5	4-01-57-00/1	4-01-57-00/2
M3,5x0,65	4-01-58-00/1	4-01-58-00/2

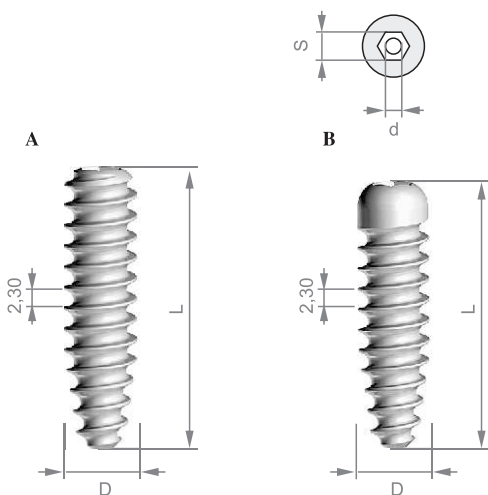

ВИНТ ИНТЕРФЕРЕНТНЫЙ
для крестообразной связки
INTERFERENCE KNEE SCREW



ШАЙБА
WASHER
4-01-61-12



ПЛАСТИНА ENDOBUTTON
ENDOBUTTON PLATE
4 x 12
4-01-61-11

D [mm]	L [mm]	Ø проводника d [mm]	S [mm]	ТВЁРДЫЙ/HARD		МЯГКИЙ/SOFT	
				А	В	А	В
6	20	1,2	2,5	4-01-61-01/20	4-01-64-01/20	4-01-62-01/20	4-01-63-01/20
6	25	1,2	2,5	4-01-61-01/25	4-01-64-01/25	4-01-62-01/25	4-01-63-01/25
6	30	1,2	2,5	4-01-61-01/30	4-01-64-01/30	4-01-62-01/30	4-01-63-01/30
6	35	1,2	2,5	4-01-61-01/35	4-01-64-01/35	4-01-62-01/35	4-01-63-01/35
6	40	1,2	2,5	4-01-61-01/40	4-01-64-01/40	4-01-62-01/40	4-01-63-01/40
6	45	1,2	2,5	4-01-61-01/45	4-01-64-01/45	4-01-62-01/45	4-01-63-01/45
6	50	1,2	2,5	4-01-61-01/50	4-01-64-01/50	4-01-62-01/50	4-01-63-01/50
7	20	2,0	3,5	4-01-61-02/20	4-01-64-02/20	4-01-62-02/20	4-01-63-02/20
7	25	2,0	3,5	4-01-61-02/25	4-01-64-02/25	4-01-62-02/25	4-01-63-02/25
7	30	2,0	3,5	4-01-61-02/30	4-01-64-02/30	4-01-62-02/30	4-01-63-02/30
7	35	2,0	3,5	4-01-61-02/35	4-01-64-02/35	4-01-62-02/35	4-01-63-02/35
7	40	2,0	3,5	4-01-61-02/40	4-01-64-02/40	4-01-62-02/40	4-01-63-02/40
7	45	2,0	3,5	4-01-61-02/45	4-01-64-02/45	4-01-62-02/45	4-01-63-02/45
7	50	2,0	3,5	4-01-61-02/50	4-01-64-02/50	4-01-62-02/50	4-01-63-02/50
8	20	2,0	3,5	4-01-61-03/20	4-01-64-03/20	4-01-62-03/20	4-01-63-03/20
8	25	2,0	3,5	4-01-61-03/25	4-01-64-03/25	4-01-62-03/25	4-01-63-03/25
8	30	2,0	3,5	4-01-61-03/30	4-01-64-03/30	4-01-62-03/30	4-01-63-03/30
8	35	2,0	3,5	4-01-61-03/35	4-01-64-03/35	4-01-62-03/35	4-01-63-03/35
8	40	2,0	3,5	4-01-61-03/40	4-01-64-03/40	4-01-62-03/40	4-01-63-03/40
8	45	2,0	3,5	4-01-61-03/45	4-01-64-03/45	4-01-62-03/45	4-01-63-03/45
8	50	2,0	3,5	4-01-61-03/50	4-01-64-03/50	4-01-62-03/50	4-01-63-03/50
9	20	2,0	3,5	4-01-61-04/20	4-01-64-04/20	4-01-62-04/20	4-01-63-04/20
9	25	2,0	3,5	4-01-61-04/25	4-01-64-04/25	4-01-62-04/25	4-01-63-04/25
9	30	2,0	3,5	4-01-61-04/30	4-01-64-04/30	4-01-62-04/30	4-01-63-04/30
9	35	2,0	3,5	4-01-61-04/35	4-01-64-04/35	4-01-62-04/35	4-01-63-04/35
9	40	2,0	3,5	4-01-61-04/40	4-01-64-04/40	4-01-62-04/40	4-01-63-04/40
9	45	2,0	3,5	4-01-61-04/45	4-01-64-04/45	4-01-62-04/45	4-01-63-04/45
9	50	2,0	3,5	4-01-61-04/50	4-01-64-04/50	4-01-62-04/50	4-01-63-04/50
10	20	2,0	3,5	4-01-61-05/20	4-01-64-05/20	4-01-62-05/20	4-01-63-05/20
10	25	2,0	3,5	4-01-61-05/25	4-01-64-05/25	4-01-62-05/25	4-01-63-05/25
10	30	2,0	3,5	4-01-61-05/30	4-01-64-05/30	4-01-62-05/30	4-01-63-05/30
10	35	2,0	3,5	4-01-61-05/35	4-01-64-05/35	4-01-62-05/35	4-01-63-05/35
10	40	2,0	3,5	4-01-61-05/40	4-01-64-05/40	4-01-62-05/40	4-01-63-05/40
10	45	2,0	3,5	4-01-61-05/45	4-01-64-05/45	4-01-62-05/45	4-01-63-05/45
10	50	2,0	3,5	4-01-61-05/50	4-01-64-05/50	4-01-62-05/50	4-01-63-05/50

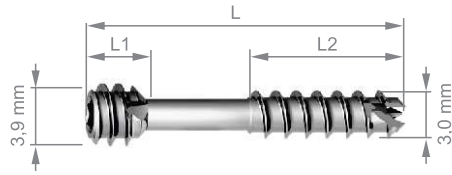

ВИНТ КОМПРЕССИОННЫЙ КАНЮЛИРОВАННЫЙ
COMPRESSION CANNULATED SCREW
 ø 3,0 ø 3,9mm

L [mm]	L1 [mm]	L2 [mm]	№ кат.
12	3,5	4	4-01-74-12
14	3,5	6	4-01-74-14
16	3,5	8	4-01-74-16
18	4	9	4-01-74-18
20	4	10	4-01-74-20
22	4	11	4-01-74-22
24	4	12	4-01-74-24
26	4	13	4-01-74-26
28	4	14	4-01-74-28
30	4	15	4-01-74-30

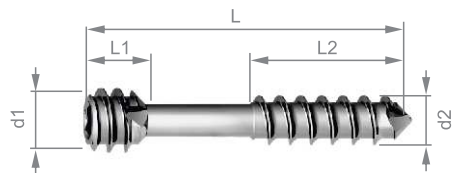

ВИНТ КОМПРЕССИОННЫЙ ЦЕЛЬНЫЙ
SOLID COMPRESSION SCREW

L [mm]	L1 [mm]	L2 [mm]	d ₁ = 3,2mm	d ₁ = 3,9mm
			d ₂ = 2,5mm	d ₂ = 3,0mm
12	3,5	4	4-01-75-12	4-01-76-12
14	3,5	6	4-01-75-14	4-01-76-14
16	3,5	8	4-01-75-16	4-01-76-16
18	4	9	4-01-75-18	4-01-76-18
20	4	10	4-01-75-20	4-01-76-20
22	4	11	4-01-75-22	4-01-76-22
24	4	12	4-01-75-24	4-01-76-24
26	4	13	4-01-75-26	4-01-76-26
28	4	14	4-01-75-28	4-01-76-28
30	4	15	4-01-75-30	4-01-76-30

**ВИНТ КОМПРЕССИОННЫЙ
КАНЮЛИРОВАННЫЙ
COMPRESSION
CANNULATED SCREW**



L [mm]	○	L [mm]	○
30	4-01-264-30	95	4-01-264-95
35	4-01-264-35	100	4-01-264-100
40	4-01-264-40	105	4-01-264-105
45	4-01-264-45	110	4-01-264-110
50	4-01-264-50	115	4-01-264-115
55	4-01-264-55	120	4-01-264-120
60	4-01-264-60	125	4-01-264-125
65	4-01-264-65	130	4-01-264-130
70	4-01-264-70	135	4-01-264-135
75	4-01-264-75	140	4-01-264-140
80	4-01-264-80	145	4-01-264-145
85	4-01-264-85	150	4-01-264-150
90	4-01-264-90		

**ВИНТ КОМПРЕССИОННЫЙ
КАНЮЛИРОВАННЫЙ
COMPRESSION
CANNULATED SCREW**

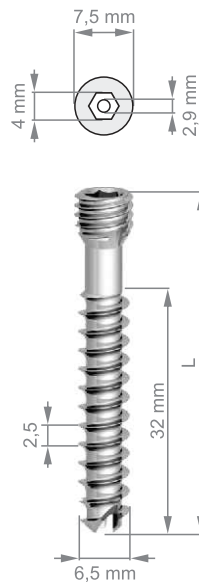

L [mm]	○	L [mm]	○
45	4-01-265-45	100	4-01-265-100
50	4-01-265-50	105	4-01-265-105
55	4-01-265-55	110	4-01-265-110
60	4-01-265-60	115	4-01-265-115
65	4-01-265-65	120	4-01-265-120
70	4-01-265-70	125	4-01-265-125
75	4-01-265-75	130	4-01-265-130
80	4-01-265-80	135	4-01-265-135
85	4-01-265-85	140	4-01-265-140
90	4-01-265-90	145	4-01-265-145
95	4-01-265-95	150	4-01-265-150

**ВИНТ КОМПРЕССИОННЫЙ
КАНЮЛИРОВАННЫЙ
COMPRESSION
CANNULATED SCREW**

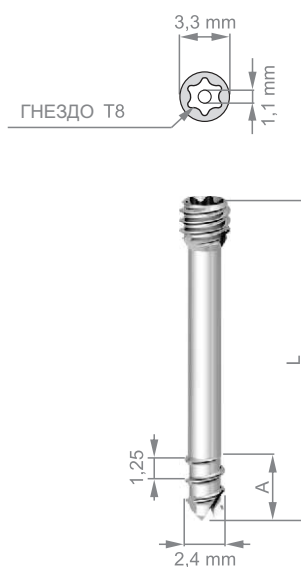

L [mm]	A [mm]	⊗	L [mm]	A [mm]	⊗
9	4	4-01-271-09	23	4	4-01-271-23
10	4	4-01-271-10	24	5	4-01-271-24
11	4	4-01-271-11	25	5	4-01-271-25
12	4	4-01-271-12	26	5	4-01-271-26
13	4	4-01-271-13	27	6	4-01-271-27
14	4	4-01-271-14	28	6	4-01-271-28
15	4	4-01-271-15	29	6	4-01-271-29
16	4	4-01-271-16	30	7	4-01-271-30
17	4	4-01-271-17	32	7	4-01-271-32
18	4	4-01-271-18	34	8	4-01-271-34
19	4	4-01-271-19	36	9	4-01-271-36
20	4	4-01-271-20	38	9	4-01-271-38
21	4	4-01-271-21	40	10	4-01-271-40
22	4	4-01-271-22			

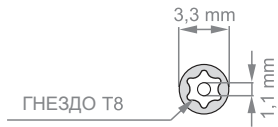

**ВИНТ КОМПРЕССИОННЫЙ
КАНЮЛИРОВАННЫЙ
COMPRESSION
CANNULATED SCREW**

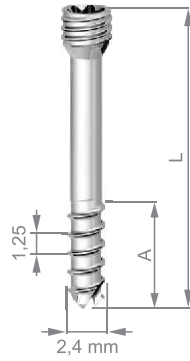

L [mm]	A [mm]	☼	L [mm]	A [mm]	☼
14	5	4-01-272-14	26	10	4-01-272-26
16	5	4-01-272-16	27	10	4-01-272-27
17	6	4-01-272-17	28	10	4-01-272-28
18	6	4-01-272-18	29	10	4-01-272-29
19	7	4-01-272-19	30	12	4-01-272-30
20	7	4-01-272-20	32	12	4-01-272-32
21	8	4-01-272-21	34	14	4-01-272-34
22	8	4-01-272-22	36	14	4-01-272-36
23	8	4-01-272-23	38	16	4-01-272-38
24	8	4-01-272-24	40	16	4-01-272-40
25	8	4-01-272-25			

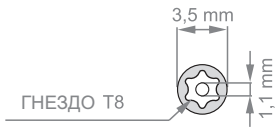

**ВИНТ КОМПРЕССИОННЫЙ
КАНЮЛИРОВАННЫЙ
COMPRESSION
CANNULATED SCREW**

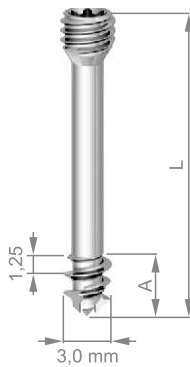

L [mm]	A [mm]	☼	L [mm]	A [mm]	☼
10	4	4-01-294-10	23	4	4-01-294-23
11	4	4-01-294-11	24	5	4-01-294-24
12	4	4-01-294-12	25	5	4-01-294-25
13	4	4-01-294-13	26	5	4-01-294-26
14	4	4-01-294-14	27	6	4-01-294-27
15	4	4-01-294-15	28	6	4-01-294-28
16	4	4-01-294-16	29	6	4-01-294-29
17	4	4-01-294-17	30	7	4-01-294-30
18	4	4-01-294-18	32	7	4-01-294-32
19	4	4-01-294-19	34	8	4-01-294-34
20	4	4-01-294-20	36	9	4-01-294-36
21	4	4-01-294-21	38	9	4-01-294-38
22	4	4-01-294-22	40	10	4-01-294-40

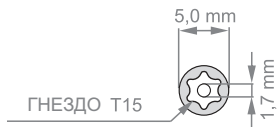

**ВИНТ КОМПРЕССИОННЫЙ
КАНЮЛИРОВАННЫЙ
COMPRESSION
CANNULATED SCREW**

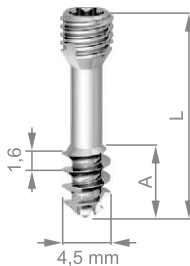

L [mm]	A [mm]	☼	L [mm]	A [mm]	☼
20	7	4-01-273-20	52	10	4-01-273-52
22	7	4-01-273-22	54	11	4-01-273-54
24	7	4-01-273-24	56	11	4-01-273-56
26	7	4-01-273-26	58	11	4-01-273-58
28	7	4-01-273-28	60	12	4-01-273-60
30	7	4-01-273-30	65	13	4-01-273-65
32	7	4-01-273-32	70	14	4-01-273-70
34	7	4-01-273-34	75	15	4-01-273-75
36	7	4-01-273-36	80	16	4-01-273-80
38	7	4-01-273-38	85	17	4-01-273-85
40	8	4-01-273-40	90	18	4-01-273-90
42	8	4-01-273-42	95	19	4-01-273-95
44	9	4-01-273-44	100	20	4-01-273-100
46	9	4-01-273-46	105	21	4-01-273-105
48	9	4-01-273-48	110	22	4-01-273-110
50	10	4-01-273-50			

**ВИНТ КОМПРЕССИОННЫЙ
КАНЮЛИРОВАННЫЙ
COMPRESSION
CANNULATED SCREW**

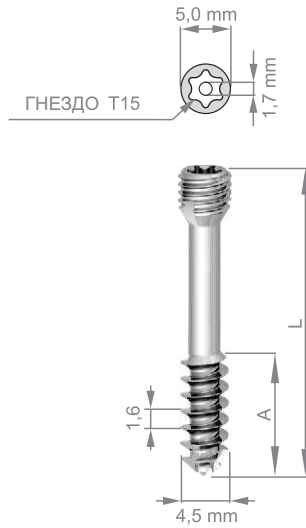

L [mm]	A [mm]		L [mm]	A [mm]	
30	12	4-01-274-30	56	22	4-01-274-56
32	12	4-01-274-32	58	22	4-01-274-58
34	12	4-01-274-34	60	24	4-01-274-60
36	14	4-01-274-36	65	26	4-01-274-65
38	14	4-01-274-38	70	28	4-01-274-70
40	16	4-01-274-40	75	30	4-01-274-75
42	16	4-01-274-42	80	32	4-01-274-80
44	18	4-01-274-44	85	34	4-01-274-85
46	18	4-01-274-46	90	36	4-01-274-90
48	18	4-01-274-48	95	38	4-01-274-95
50	20	4-01-274-50	100	40	4-01-274-100
52	20	4-01-274-52	105	42	4-01-274-105
54	22	4-01-274-54	110	44	4-01-274-110

**ВИНТ КОМПРЕССИОННЫЙ
COMPRESSION SCREW**

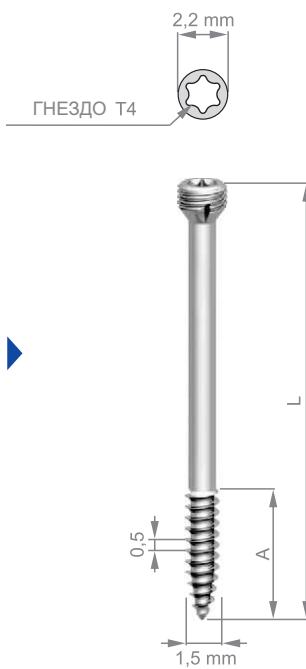

L [mm]	A [mm]	
8	4	4-01-278-08
9	4	4-01-278-09
10	4	4-01-278-10
11	4	4-01-278-11
12	4	4-01-278-12
13	4	4-01-278-13
14	4	4-01-278-14
15	4	4-01-278-15
16	5	4-01-278-16
17	5	4-01-278-17
18	5	4-01-278-18
19	5	4-01-278-19
20	6	4-01-278-20

**ВИНТ КАНЮЛИРОВАННЫЙ
самосверлящий**
CANNULATED SCREW
self-drilling

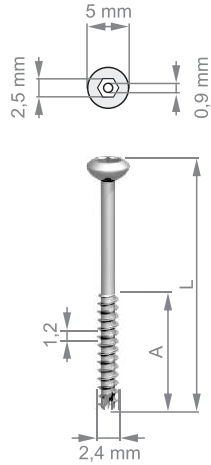

L [mm]	A [mm]	⊙	L [mm]	A [mm]	⊙
10	4	4-01-285-10	18	8	4-01-285-18
11	5	4-01-285-11	19	9	4-01-285-19
12	5	4-01-285-12	20	9	4-01-285-20
13	6	4-01-285-13	22	10	4-01-285-22
14	6	4-01-285-14	24	10	4-01-285-24
15	7	4-01-285-15	26	12	4-01-285-26
16	7	4-01-285-16	28	12	4-01-285-28
17	8	4-01-285-17	30	14	4-01-285-30

**ВИНТ КАНЮЛИРОВАННЫЙ
самосверлящий**
CANNULATED SCREW
self-drilling

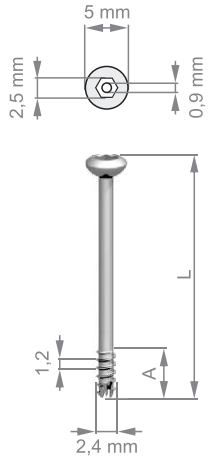

L [mm]	A [mm]	⊙	L [mm]	A [mm]	⊙
17	5	4-01-286-17	24	6	4-01-286-24
18	5	4-01-286-18	26	6	4-01-286-26
19	5	4-01-286-19	28	6	4-01-286-28
20	5	4-01-286-20	30	6	4-01-286-30
22	5	4-01-286-22			

**ВИНТ КАНЮЛИРОВАННЫЙ
самосверлящий**
CANNULATED SCREW
self-drilling

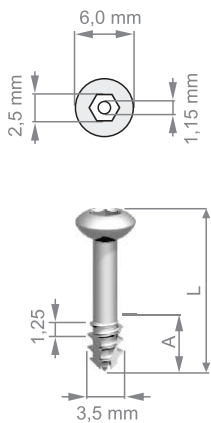

L [mm]	A [mm]	⊙	L [mm]	A [mm]	⊙
10	4	4-01-101-10	36	12	4-01-101-36
12	4	4-01-101-12	38	12	4-01-101-38
14	5	4-01-101-14	40	13	4-01-101-40
16	5	4-01-101-16	42	14	4-01-101-42
18	6	4-01-101-18	44	14	4-01-101-44
20	7	4-01-101-20	46	15	4-01-101-46
22	7	4-01-101-22	48	15	4-01-101-48
24	8	4-01-101-24	50	16	4-01-101-50
26	8	4-01-101-26	52	16	4-01-101-52
28	9	4-01-101-28	54	17	4-01-101-54
30	10	4-01-101-30	56	18	4-01-101-56
32	11	4-01-101-32	58	19	4-01-101-58
34	11	4-01-101-34	60	20	4-01-101-60

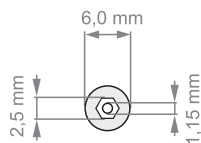

**ВИНТ КАНЮЛИРОВАННЫЙ
самосверлящий**
**CANNULATED SCREW
self-drilling**

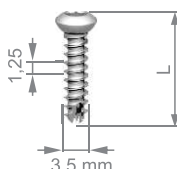

L [mm]	⊙	L [mm]	⊙
8	4-01-100-08	40	4-01-100-40
10	4-01-100-10	42	4-01-100-42
12	4-01-100-12	44	4-01-100-44
14	4-01-100-14	46	4-01-100-46
16	4-01-100-16	48	4-01-100-48
18	4-01-100-18	50	4-01-100-50
20	4-01-100-20	52	4-01-100-52
22	4-01-100-22	54	4-01-100-54
24	4-01-100-24	56	4-01-100-56
26	4-01-100-26	58	4-01-100-58
28	4-01-100-28	60	4-01-100-60
30	4-01-100-30	62	4-01-100-62
32	4-01-100-32	64	4-01-100-64
34	4-01-100-34	66	4-01-100-66
36	4-01-100-36	68	4-01-100-68
38	4-01-100-38	70	4-01-100-70

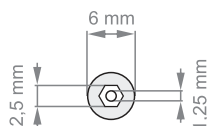

**ВИНТ КАНЮЛИРОВАННЫЙ
самосверлящий**
**CANNULATED SCREW
self-drilling**

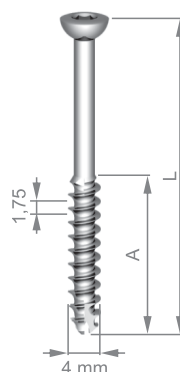

L [mm]	A [mm]	⊙	L [mm]	A [mm]	⊙
16	8	4-01-232-16	46	23	4-01-232-46
18	9	4-01-232-18	48	24	4-01-232-48
20	10	4-01-232-20	50	25	4-01-232-50
22	11	4-01-232-22	52	26	4-01-232-52
24	12	4-01-232-24	54	27	4-01-232-54
26	13	4-01-232-26	56	28	4-01-232-56
28	14	4-01-232-28	58	29	4-01-232-58
30	15	4-01-232-30	60	30	4-01-232-60
32	16	4-01-232-32	62	31	4-01-232-62
34	17	4-01-232-34	64	32	4-01-232-64
36	18	4-01-232-36	66	33	4-01-232-66
38	19	4-01-232-38	68	34	4-01-232-68
40	20	4-01-232-40	70	35	4-01-232-70
42	21	4-01-232-42	72	36	4-01-232-72
44	22	4-01-232-44			

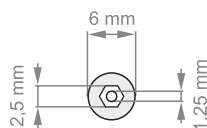

**ВИНТ КАНЮЛИРОВАННЫЙ
самосверлящий**
**CANNULATED SCREW
self-drilling**

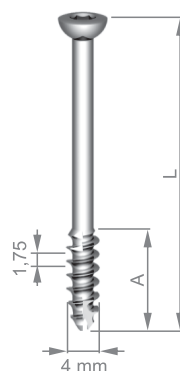

L [mm]	A [mm]	⊙	L [mm]	A [mm]	⊙
10	5	4-01-231-10	42	14	4-01-231-42
12	5	4-01-231-12	44	14	4-01-231-44
14	5	4-01-231-14	46	15	4-01-231-46
16	5	4-01-231-16	48	15	4-01-231-48
18	6	4-01-231-18	50	16	4-01-231-50
20	7	4-01-231-20	52	17	4-01-231-52
22	7	4-01-231-22	54	18	4-01-231-54
24	8	4-01-231-24	56	19	4-01-231-56
26	9	4-01-231-26	58	19	4-01-231-58
28	9	4-01-231-28	60	20	4-01-231-60
30	10	4-01-231-30	62	21	4-01-231-62
32	11	4-01-231-32	64	21	4-01-231-64
34	11	4-01-231-34	66	22	4-01-231-66
36	12	4-01-231-36	68	23	4-01-231-68
38	12	4-01-231-38	70	23	4-01-231-70
40	13	4-01-231-40	72	24	4-01-231-72

**ВИНТ КАНЮЛИРОВАННЫЙ
самосверлящий**
CANNULATED SCREW
self-drilling

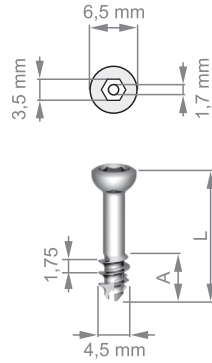

**ВИНТ КАНЮЛИРОВАННЫЙ
самосверлящий**
CANNULATED SCREW
self-drilling

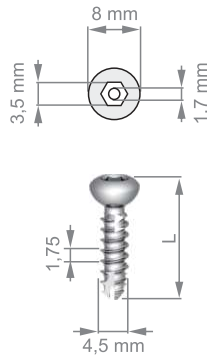

**ВИНТ КАНЮЛИРОВАННЫЙ
самосверлящий**
CANNULATED SCREW
self-drilling

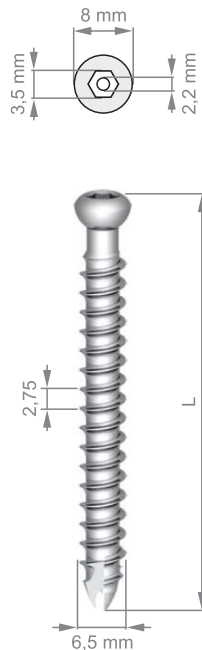

L [mm]	A [mm]	⊙	L [mm]	A [mm]	⊙
20	7	4-01-266-20	46	15	4-01-266-46
22	7	4-01-266-22	48	16	4-01-266-48
24	8	4-01-266-24	50	17	4-01-266-50
26	9	4-01-266-26	52	17	4-01-266-52
28	9	4-01-266-28	54	18	4-01-266-54
30	10	4-01-266-30	56	19	4-01-266-56
32	11	4-01-266-32	60	20	4-01-266-60
34	11	4-01-266-34	64	21	4-01-266-64
36	12	4-01-266-36	68	23	4-01-266-68
38	13	4-01-266-38	72	24	4-01-266-72
40	13	4-01-266-40	76	25	4-01-266-76
42	14	4-01-266-42	80	26	4-01-266-80
44	15	4-01-266-44			



L [mm]	⊙	L [mm]	⊙
20	4-01-233-20	46	4-01-233-46
22	4-01-233-22	48	4-01-233-48
24	4-01-233-24	50	4-01-233-50
26	4-01-233-26	52	4-01-233-52
28	4-01-233-28	54	4-01-233-54
30	4-01-233-30	56	4-01-233-56
32	4-01-233-32	60	4-01-233-60
34	4-01-233-34	64	4-01-233-64
36	4-01-233-36	68	4-01-233-68
38	4-01-233-38	70	4-01-233-70
40	4-01-233-40	72	4-01-233-72
42	4-01-233-42	76	4-01-233-76
44	4-01-233-44	80	4-01-233-80



L [mm]	⊙	L [mm]	⊙
20	4-01-235-20	85	4-01-235-85
25	4-01-235-25	90	4-01-235-90
30	4-01-235-30	95	4-01-235-95
35	4-01-235-35	100	4-01-235-100
40	4-01-235-40	105	4-01-235-105
45	4-01-235-45	110	4-01-235-110
50	4-01-235-50	115	4-01-235-115
55	4-01-235-55	120	4-01-235-120
60	4-01-235-60	125	4-01-235-125
65	4-01-235-65	130	4-01-235-130
70	4-01-235-70	135	4-01-235-135
75	4-01-235-75	140	4-01-235-140
80	4-01-235-80		

**ВИНТ КАНЮЛИРОВАННЫЙ
самосверлящий**
CANNULATED SCREW
self-drilling

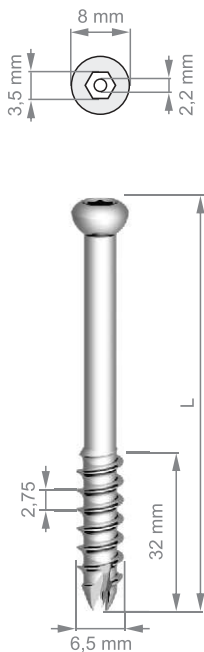

L [mm]	⊙	L [mm]	⊙
45	4-01-236-45	95	4-01-236-95
50	4-01-236-50	100	4-01-236-100
55	4-01-236-55	105	4-01-236-105
60	4-01-236-60	110	4-01-236-110
65	4-01-236-65	115	4-01-236-115
70	4-01-236-70	120	4-01-236-120
75	4-01-236-75	125	4-01-236-125
80	4-01-236-80	130	4-01-236-130
85	4-01-236-85	135	4-01-236-135
90	4-01-236-90	140	4-01-236-140

**ВИНТ КАНЮЛИРОВАННЫЙ
самосверлящий**
CANNULATED SCREW
self-drilling



L [mm]	⊙	L [mm]	⊙
30	4-01-237-30	90	4-01-237-90
35	4-01-237-35	95	4-01-237-95
40	4-01-237-40	100	4-01-237-100
45	4-01-237-45	105	4-01-237-105
50	4-01-237-50	110	4-01-237-110
55	4-01-237-55	115	4-01-237-115
60	4-01-237-60	120	4-01-237-120
65	4-01-237-65	125	4-01-237-125
70	4-01-237-70	130	4-01-237-130
75	4-01-237-75	135	4-01-237-135
80	4-01-237-80	140	4-01-237-140
85	4-01-237-85		

**ВИНТ КАНЮЛИРОВАННЫЙ
самосверлящий**
CANNULATED SCREW
self-drilling

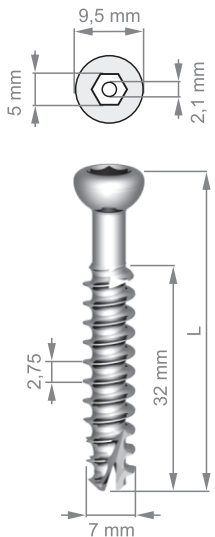

L [mm]	⊙	L [mm]	⊙
45	4-01-269-45	100	4-01-269-100
50	4-01-269-50	105	4-01-269-105
55	4-01-269-55	110	4-01-269-110
60	4-01-269-60	115	4-01-269-115
65	4-01-269-65	120	4-01-269-120
70	4-01-269-70	125	4-01-269-125
75	4-01-269-75	130	4-01-269-130
80	4-01-269-80	135	4-01-269-135
85	4-01-269-85	140	4-01-269-140
90	4-01-269-90	145	4-01-269-145
95	4-01-269-95	150	4-01-269-150

**ВИНТ КАНЮЛИРОВАННЫЙ
самосверлящий**
CANNULATED SCREW
self-drilling

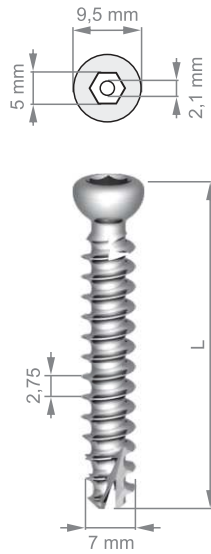

L [mm]	⊙	L [mm]	⊙
20	4-01-270-20	80	4-01-270-80
25	4-01-270-25	85	4-01-270-85
30	4-01-270-30	90	4-01-270-90
35	4-01-270-35	95	4-01-270-95
40	4-01-270-40	100	4-01-270-100
45	4-01-270-45	105	4-01-270-105
50	4-01-270-50	110	4-01-270-110
55	4-01-270-55	115	4-01-270-115
60	4-01-270-60	120	4-01-270-120
65	4-01-270-65	125	4-01-270-125
70	4-01-270-70	130	4-01-270-130
75	4-01-270-75		

**ВИНТ КАНЮЛИРОВАННЫЙ
самосверлящий**
CANNULATED SCREW
self-drilling

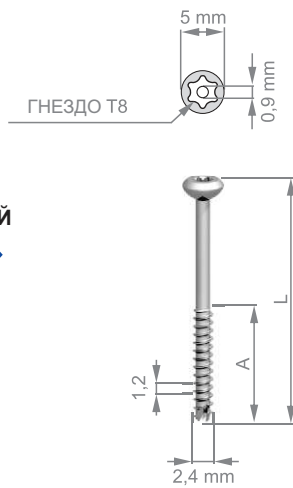

L [mm]	A [mm]	⊙	L [mm]	A [mm]	⊙
10	4	4-01-283-10	18	8	4-01-283-18
11	5	4-01-283-11	19	9	4-01-283-19
12	5	4-01-283-12	20	9	4-01-283-20
13	6	4-01-283-13	22	10	4-01-283-22
14	6	4-01-283-14	24	10	4-01-283-24
15	7	4-01-283-15	26	12	4-01-283-26
16	7	4-01-283-16	28	12	4-01-283-28
17	8	4-01-283-17	30	14	4-01-283-30

**ВИНТ КАНЮЛИРОВАННЫЙ
самосверлящий**
CANNULATED SCREW
self-drilling

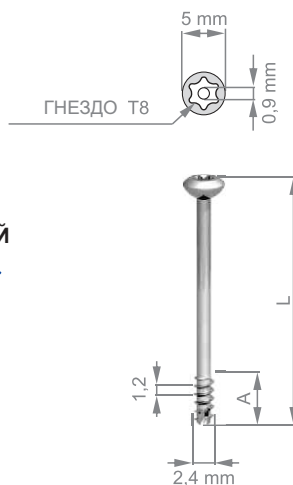

L [mm]	A [mm]	⊙	L [mm]	A [mm]	⊙
17	5	4-01-284-17	24	6	4-01-284-24
18	5	4-01-284-18	26	6	4-01-284-26
19	5	4-01-284-19	28	6	4-01-284-28
20	5	4-01-284-20	30	6	4-01-284-30
22	5	4-01-284-22			

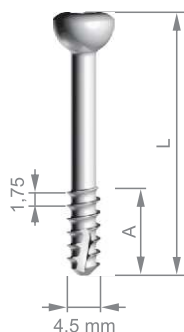
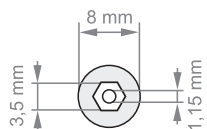

ВИНТ КАНЮЛИРОВАННЫЙ самонарезающий
CANNULATED SCREW self-tapping

L [mm]	A [mm]	⊙	L [mm]	A [mm]	⊙
10	-	4-01-78-01	70	12	4-01-78-74
12	-	4-01-78-02	75	12	4-01-78-75
14	-	4-01-78-03	80	12	4-01-78-76
16	-	4-01-78-04	30	15	4-01-78-86
18	11	4-01-78-05	50	16	4-01-78-77
20	12	4-01-78-06	55	16	4-01-78-78
22	12	4-01-78-07	60	16	4-01-78-79
24	12	4-01-78-08	35	18	4-01-78-87
25	12	4-01-78-85	40	20	4-01-78-88
26	12	4-01-78-09	45	22	4-01-78-89
28	12	4-01-78-10	50	24	4-01-78-90
30	12	4-01-78-11	55	26	4-01-78-91
35	12	4-01-78-12	60	30	4-01-78-92
40	12	4-01-78-13	65	30	4-01-78-93
45	12	4-01-78-14	70	32	4-01-78-94
50	12	4-01-78-70	75	32	4-01-78-95
55	12	4-01-78-71	80	32	4-01-78-96
60	12	4-01-78-72	85	32	4-01-78-105
65	12	4-01-78-73	90	32	4-01-78-110

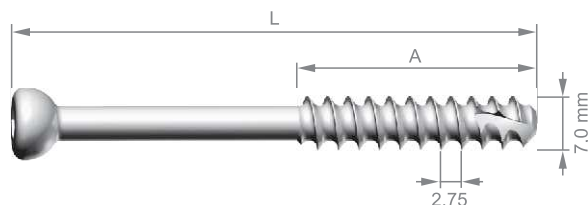
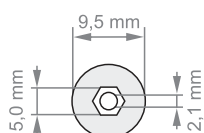

ВИНТ КАНЮЛИРОВАННЫЙ самонарезающий
CANNULATED SCREW self-tapping

ВИНТ КАНЮЛИРОВАННЫЙ самонарезающий
CANNULATED SCREW self-tapping

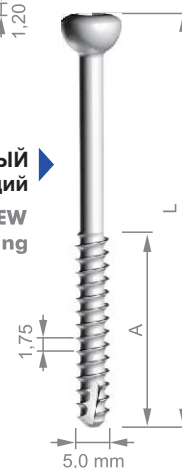
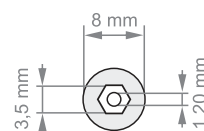

L [mm]	A [mm]	⊙	L [mm]	A [mm]	⊙
40	16	4-01-78-32	40	27	4-01-78-98
45	16	4-01-78-33	40	32	4-01-78-51
50	16	4-01-78-34	45	32	4-01-78-52
55	16	4-01-78-35	50	32	4-01-78-53
60	16	4-01-78-36	55	32	4-01-78-54
65	16	4-01-78-37	60	32	4-01-78-55
70	16	4-01-78-38	65	32	4-01-78-56
75	16	4-01-78-39	70	32	4-01-78-57
80	16	4-01-78-40	75	32	4-01-78-58
85	16	4-01-78-41	80	32	4-01-78-59
90	16	4-01-78-42	85	32	4-01-78-60
95	16	4-01-78-43	90	32	4-01-78-61
100	16	4-01-78-44	95	32	4-01-78-62
105	16	4-01-78-45	100	32	4-01-78-63
110	16	4-01-78-46	105	32	4-01-78-64
115	16	4-01-78-47	110	32	4-01-78-65
120	16	4-01-78-48	115	32	4-01-78-66
125	16	4-01-78-49	120	32	4-01-78-67
130	16	4-01-78-50	125	32	4-01-78-68
35	22	4-01-78-97	130	32	4-01-78-69

L [mm]	A [mm]	⊙
25	16	4-01-78-15
30	16	4-01-78-16
35	16	4-01-78-17
40	16	4-01-78-18
45	16	4-01-78-19
50	16	4-01-78-20
55	16	4-01-78-21
60	16	4-01-78-22
65	16	4-01-78-23
70	16	4-01-78-24
40	32	4-01-78-25
45	32	4-01-78-26
50	32	4-01-78-27
55	32	4-01-78-28
60	32	4-01-78-29
65	32	4-01-78-30
70	32	4-01-78-31

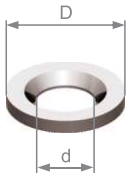

ШАЙБА
WASHER

D [mm]	d [mm]	№ кат.
6,5	3,3	4-01-289-01
7,0	3,6	4-01-289-02
10,0	4,6	4-01-289-03
13,0	6,6	4-01-289-04



ВИНТ ОПОРНЫЙ \varnothing 3,0
SUPPORT SCREW \varnothing 3,0
4-01-292-01



ШАЙБА
WASHER
4-01-290-01



ШАЙБА
WASHER
4-01-291-01

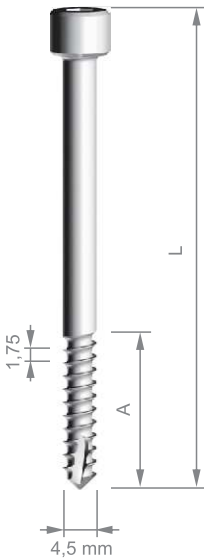
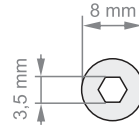
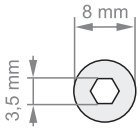

ВИНТ БЛОКИРУЮЩИЙ ПРОКСИМАЛЬНЫЙ
самонарезающий
LOCKING SHAFT SCREW
self-tapping
 \varnothing 4,5 x 1,75mm



ВИНТ БЛОКИРУЮЩИЙ ПРОКСИМАЛЬНЫЙ
самонарезающий
LOCKING SHAFT SCREW
self-tapping
 \varnothing 6,5 x 2,75mm



A [mm]	L [mm]	⊙	A [mm]	L [mm]	⊙
12	26	4-01-81-26	20	64	4-01-81-64
12	28	4-01-81-28	20	66	4-01-81-66
12	30	4-01-81-30	20	68	4-01-81-68
12	32	4-01-81-32	20	70	4-01-81-70
12	34	4-01-81-34	20	72	4-01-81-72
16	36	4-01-81-36	20	74	4-01-81-74
16	38	4-01-81-38	20	76	4-01-81-76
16	40	4-01-81-40	20	78	4-01-81-78
16	42	4-01-81-42	20	80	4-01-81-80
16	44	4-01-81-44	20	82	4-01-81-82
16	46	4-01-81-46	20	84	4-01-81-84
16	48	4-01-81-48	20	86	4-01-81-86
18	50	4-01-81-50	20	88	4-01-81-88
18	52	4-01-81-52	20	90	4-01-81-90
18	54	4-01-81-54	20	92	4-01-81-92
18	56	4-01-81-56	20	94	4-01-81-94
18	58	4-01-81-58	20	96	4-01-81-96
18	60	4-01-81-60	20	98	4-01-81-98
18	62	4-01-81-62	20	100	4-01-81-100

L [mm]	⊙
40	4-01-84-40
45	4-01-84-45
50	4-01-84-50
55	4-01-84-55
60	4-01-84-60
65	4-01-84-65
70	4-01-84-70
75	4-01-84-75
80	4-01-84-80
85	4-01-84-85
90	4-01-84-90
95	4-01-84-95
100	4-01-84-100
105	4-01-84-105
110	4-01-84-110
115	4-01-84-115
120	4-01-84-120
125	4-01-84-125
130	4-01-84-130
135	4-01-84-135
140	4-01-84-140

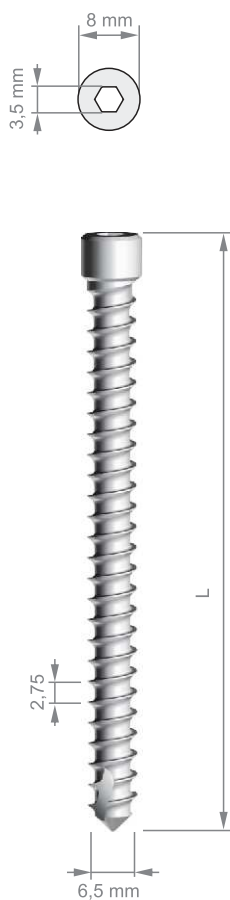

▲
**ВИНТ БЛОКИРУЮЩИЙ
 самонарезающий**
**LOCKING SCREW
 self-tapping**
ø 6,5 x 2,75mm



L [mm]	⊙	L [mm]	⊙
40	4-01-85-40	82	4-01-85-82
42	4-01-85-42	84	4-01-85-84
44	4-01-85-44	86	4-01-85-86
46	4-01-85-46	88	4-01-85-88
48	4-01-85-48	90	4-01-85-90
50	4-01-85-50	92	4-01-85-92
52	4-01-85-52	94	4-01-85-94
54	4-01-85-54	96	4-01-85-96
56	4-01-85-56	98	4-01-85-98
58	4-01-85-58	100	4-01-85-100
60	4-01-85-60	102	4-01-85-102
62	4-01-85-62	104	4-01-85-104
64	4-01-85-64	106	4-01-85-106
66	4-01-85-66	108	4-01-85-108
68	4-01-85-68	110	4-01-85-110
70	4-01-85-70	112	4-01-85-112
72	4-01-85-72	114	4-01-85-114
74	4-01-85-74	116	4-01-85-116
76	4-01-85-76	118	4-01-85-118
78	4-01-85-78	120	4-01-85-120
80	4-01-85-80		

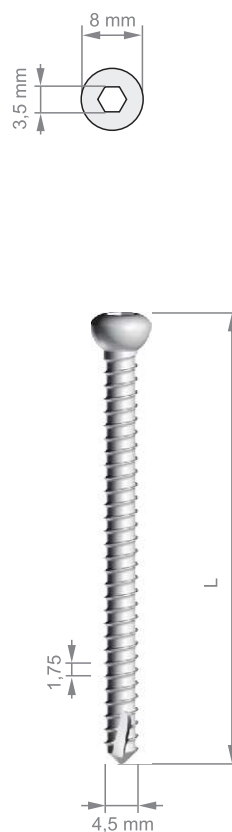

▲
**ВИНТ БЛОКИРУЮЩИЙ
 самонарезающий**
**LOCKING SCREW
 self-tapping**
ø 4,5



L [mm]	⊙	L [mm]	⊙
16	4-01-86-16	60	4-01-86-60
18	4-01-86-18	62	4-01-86-62
20	4-01-86-20	64	4-01-86-64
22	4-01-86-22	66	4-01-86-66
24	4-01-86-24	68	4-01-86-68
26	4-01-86-26	70	4-01-86-70
28	4-01-86-28	72	4-01-86-72
30	4-01-86-30	74	4-01-86-74
32	4-01-86-32	76	4-01-86-76
34	4-01-86-34	78	4-01-86-78
36	4-01-86-36	80	4-01-86-80
38	4-01-86-38	82	4-01-86-82
40	4-01-86-40	84	4-01-86-84
42	4-01-86-42	86	4-01-86-86
44	4-01-86-44	88	4-01-86-88
46	4-01-86-46	90	4-01-86-90
48	4-01-86-48	92	4-01-86-92
50	4-01-86-50	94	4-01-86-94
52	4-01-86-52	96	4-01-86-96
54	4-01-86-54	98	4-01-86-98
56	4-01-86-56	100	4-01-86-100
58	4-01-86-58		

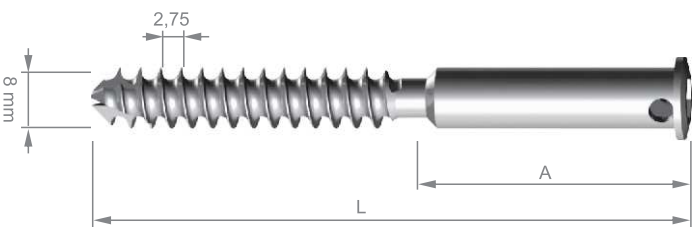
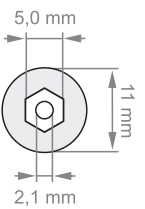

ВИНТ GARDEN'S
 самонарезающий - самосверлящий
GARDEN'S SCREW
 self-tapping - self-drilling
ø 8,0mm



L [mm]	A [mm]	
55	25	4-01-87-55
60	25	4-01-87-60
65	30	4-01-87-65
70	30	4-01-87-70
75	35	4-01-87-75
80	35	4-01-87-80
85	40	4-01-87-85
90	40	4-01-87-90
95	45	4-01-87-95
100	45	4-01-87-100
105	45	4-01-87-105
110	45	4-01-87-110
115	45	4-01-87-115
120	50	4-01-87-120
125	50	4-01-87-125
130	55	4-01-87-130
135	55	4-01-87-135
140	60	4-01-87-140
145	60	4-01-87-145
150	65	4-01-87-150

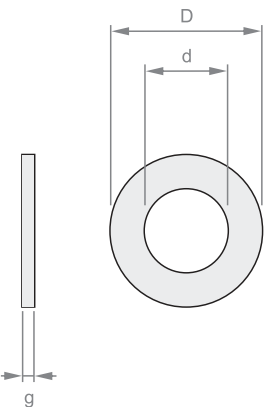

ШАЙБА
WASHER

g [mm]	d [mm]	D [mm]	ø винта	№ кат.
1	2,8	7	2,0 - 2,7	4-01-99-01
1,5	3,1	6,5	2,0 - 2,7	4-01-99-40
1,5	3,1	7	2,0 - 2,7	4-01-99-02
1,5	3,7	10	3,5	4-01-99-39
1,5	4,2	7	3,5 - 4,0	4-01-99-03
1,5	4,2	8	3,5 - 4,0	4-01-99-05
1,5	4,2	10	3,5 - 4,0	4-01-99-06
1,5	4,2	11	3,5 - 4,0	4-01-99-07
1,5	4,2	11	4,5	4-01-99-45/07
1,5	4,5	10	4,5	4-01-99-08
1,5	4,7	10	4,5	4-01-99-09
1,5	5,0	10	4,5 - 5,0	4-01-99-11
1,5	5,0	11	4,5	4-01-99-35
1,5	5,0	13	4,5 - 5,0	4-01-99-36
1,5	5,0	15	4,5 - 5,0	4-01-99-12
1,5	5,0	19	4,5 - 5,0	4-01-99-41
1,5	5,5	10	4,5 - 5,0	4-01-99-15
1,5	5,5	13	4,5 - 5,0	4-01-99-16
1,5	5,5	15	4,5 - 5,0	4-01-99-17
1,5	5,5	16	4,5 - 5,0	4-01-99-18
1,5	5,5	20	4,5 - 5,0	4-01-99-19
1,5	6	13	6,5	4-01-99-22
1,5	6,7	11	6,5	4-01-99-37
1,5	6,7	13	6,5	4-01-99-23
1,5	6,7	16	6,5	4-01-99-24
1,5	6,7	20	6,5	4-01-99-25
1,5	7,0	16	7,0	4-01-99-26
1,5	7,0	10	7,0	4-01-99-27
1,5	7,2	13	7,0	4-01-99-28
1,5	7,2	15	7,0	4-01-99-29
1,5	7,2	16	7,0	4-01-99-30
1,5	7,2	19	7,0	4-01-99-38
1,5	7,2	20	7,0	4-01-99-31
1,5	8,0	16	8,0	4-01-99-32
1,5	8,2	16	8,0	4-01-99-33
1,5	8,2	20	8,0	4-01-99-34